

Start
Here!

1

2

3

Quick Start Guide Next Page...



Quick Start Guide

WDECT 2355+2

Wide Band Digital
Technology provides
the clearest sound
and the best privacy.

Uniden[®]

INSTALLATION & SAFETY

Choosing the best location for your phone.
When choosing a location for your phone there are a number of appliances the phone should not be near, and areas you should avoid.



• This symbol indicates important operating and servicing instructions.

• The earcap of this telephone may attract and retain small metallic objects.

AVOID -
Television sets and
other electronic
appliances

AVOID -
Microwave ovens

AVOID -
moisture

CHOOSE -
a central location

AVOID -
other cordless
telephones

Note: Ringing will not be impaired by adding extra cordless handsets.

AVOID -
Moisture



CHARGE -
the new phone
for 15 - 20 hrs.

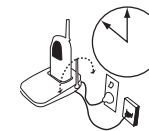

Don't -
overload the
power outlet.



AVOID -
multi power boards.



AVOID -
Computers

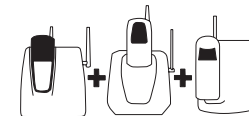

AVOID -
connecting
more than
3
phones as ringing
may be impaired

Start Here!

1 2 3

QUICK START GUIDE

This page is a very condensed version of the Owner's Manual. It is designed to allow you to get your phone installed and operating as quickly as possible - however it does not attempt to explain any of the advanced features of the WDECT2355 series.

1 Installing the Base Unit

- 1) Connect the AC adapter to the **DC IN 9V** jack and to a standard AC wall outlet.

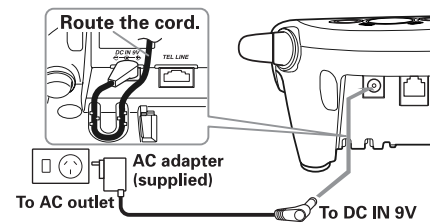

- 2) Connect the telephone line cord to the **TEL LINE** jack and to a telephone socket on the wall.

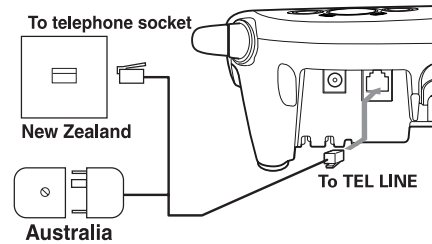

For wall mounting, see "Mounting the Base Unit on a Wall" on page 6.



Make sure the AC Adapter/s remains switched ON at all times. Use only the Uniden AC Adapter/s supplied with this unit.

- 3) Set the base on a desk or tabletop.
- 4) Raise the antenna to a vertical position.

Connecting the charger

- 1) Connect the AC adapter into the charging cradle and to a AC wall outlet.
- 2) Set the charger on a desk or tabletop.

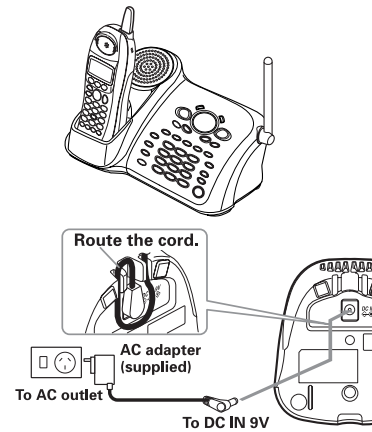

2 Installing the battery pack

- 1) Press down on the battery cover release and slide the cover down until it comes off.
- 2) Connect the battery plug to the socket at the rear of the battery compartment. The RED and BLACK battery wires must match the RED and BLACK dots on the phone case for the plug to fit properly. Press firmly until it clicks into place.
- 3) Securely close the battery compartment cover by sliding it up until it snaps into place.

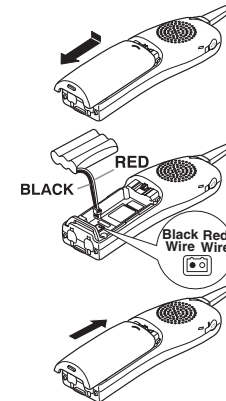

- Charge the handset battery pack for at least 15-20 hours before using your new cordless telephone for the first time.
- Use only the Uniden rechargeable battery pack (BT-446) supplied with your cordless telephone.

3 Charging the handset(s)

- 1) Place the handset(s) in the main base unit or charging cradle with the keypad facing forward.

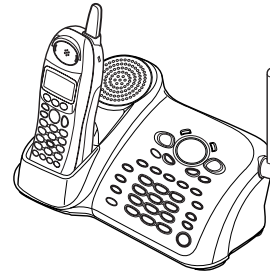

- 2) Make sure the **charge** LED illuminates. If the LED does not illuminate, check to see that the AC adapter is plugged in and that the handset makes good contact with the base charging contacts.

- After installing the batteries in the handset, charge your handset at least **15-20 hours**.



Recharge your phone on a regular basis by returning the handset to the base after each phone call.



During a power cut or if the AC adapter is switched off, this telephone will not operate.

CONTENTS

INSTALLATION & SAFETY	i	PHONEBOOK	30
QUICK START GUIDE	ii	Phonebook	30
CONTENTS	v	Storing Phone Numbers, Names, Distinctive Rings, and Speed Dial	30
GETTING STARTED	1	Steps for Entering Names and Special Characters	32
Controls and Functions	1	Viewing the Phonebook	34
Uniden Company Philosophy	3	Making Calls Using the Phonebook	35
Welcome	3	Speed Dialing	35
Features	4	Editing or Erasing a Stored Name, Phone Number, Distinctive Ring, and Speed Dial	36
Checking the Package Contents	5	Chain Dialing	37
Terminology	5	Memory Dialing (Base Only)	37
Mounting the Base Unit on a Wall	6	CALLER ID	38
Battery Maintenance	7	Caller ID	38
Installing the Beltclip	8	Viewing the Caller ID List	39
Headset Installation (Optional)	9	Deleting a Caller ID Message	40
Display and Icons	9	Using the Caller ID Message List	41
About the Menu Options	10	THE INTEGRATED ANSWERING DEVICE	42
Setting up the Menu	14	The Integrated Answering Device	42
BASICS	22	Turning the Answering System On/Off	43
Making and Receiving Calls	22	Setting up your Answering System	44
Keypad Lock	23	Using your Answering System	50
Placing a Call on Hold	23	Remote Operation	53
Redialing a Call	24	EXPANDING YOUR PHONE	56
Adjusting the Handset Ringer, Earpiece and Speaker Volume	25	Expanding your Phone	56
Do Not Disturb (DND)	26	Register the Handset	57
Mute Microphone	26	Using Two Way Communication between the Handsets Anywhere without the Base (DirectLink)	58
Tone Dialing Switch-Over (Australia Only)	27	Room Monitor	58
Traveling Out-of-Range	27	4-Way Conferencing	59
Clarity Booster	27	Intercom/Call Transfer Feature	59
Privacy Mode	28	Replacing the Base	60
3-way Conferencing	28	ADDITIONAL INFORMATION	61
Find Handset	29	Changing the Digital Security Code	61
Flash and Call Waiting	29	TROUBLESHOOTING	62
New Message LED	29	INDEX	65
		WARRANTY	66

CONTROLS AND FUNCTIONS

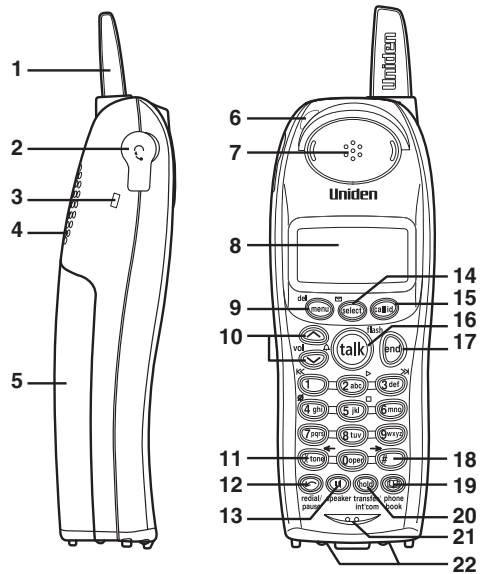

Handset Remote Operation (P. 54) (Review ITAD messages from handset)

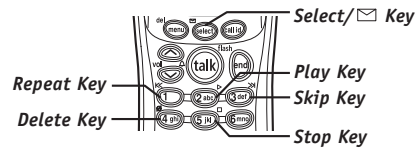

1. Handset Antenna
2. Headset Jack Cover
3. Beltclip Hole
4. Hands-Free Speaker
5. Handset Battery Compartment
6. New Message LED
7. Handset Earpiece
8. LCD Display
9. **menu** / **del** Key
10. **Δ** / **vol** / **▲** / **▼** Key
 - a. ringer volume control
 - b. scroll keys for display screen
11. **✳** / **tone** / **←** Key
12. **↶** **redial/pause** Key
13. **🔊** **speaker** Key
14. **select** / **✉** Key
15. **call id** Key
16. **talk** / **flash** Key
17. **end** Key
18. **#** / **→** Key
19. **📖** **phonebook** Key
20. **hold** / **transfer/int'com** Key
21. Handset Microphone
22. Handset Charging Contacts

GETTING STARTED

Main Base

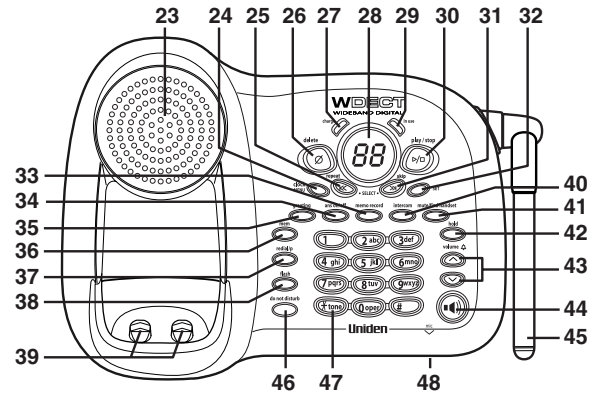

- | | |
|------------------------------|---------------------------------------|
| 23. Base Speaker | 35. Greeting Key |
| 24. Clock/MENU Key | 36. Mem Key |
| 25. repeat/SELECT Key | 37. Redial/p Key |
| 26. delete Key | 38. Flash Key |
| 27. Charge LED | 39. Base Charging Contacts |
| 28. Message Counter Display | 40. Intercom Key |
| 29. In use LED | 41. Mute/find handset Key |
| 30. play/stop Key | 42. Hold Key |
| 31. skip/SELECT Key | 43. volume ▲/▼ Key |
| 32. SET Key | 44. Key/speaker LED |
| 33. Memo record Key | 45. Base Antenna |
| 34. Ans on/off Key | 46. Do not disturb Key/DND LED |

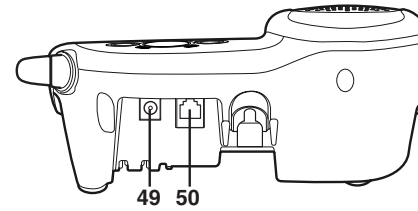

Charger Base

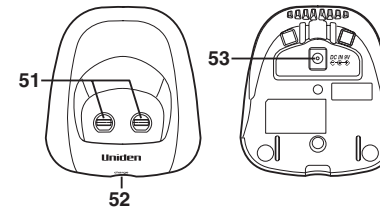

- | |
|------------------------------|
| 47. tone ✖ Key |
| 48. Microphone |
| 49. DC IN 9V Jack |
| 50. TEL LINE Jack |
| 51. Charging Contacts |
| 52. Charge LED |
| 53. DC IN 9V Jack |

UNIDEN COMPANY PHILOSOPHY

To bring outstanding wireless communication products to people's lives throughout the world.

WELCOME

Congratulations on your purchase of the Uniden Multi-Handset Cordless System telephone. This unit is different from conventional cordless telephones. When the base unit is connected to AC power and a telephone line, it can support up to 4 handsets. Using extra handsets, you can establish a 3-way conference call (2 handsets and an outside line), while two other handsets are making an intercom call. You can now place a fully featured cordless handset anywhere in your home or office where AC power is available to connect the handset chargers.

Note: The illustrations in this manual are intended as a guide and may differ from actual unit.

FEATURES

Great features of this cordless phone include:

- Designed and Engineered in Japan
- Wide Band Digital Technology
- Multi (4) Handset Capable
- Digital Duplex Speakerphone on Handset

Advanced Alpha Display Caller ID Features:

- Alpha Memory Dialling
- POP ID - Caller Name Identification*
- 20 Individual Caller Allocations
- 100 Caller ID* Memories with Phonebook
- 3 Line Backlit Full Dot Matrix LCD Display with Clock
- Maxi-Sound - Extra Loud Handset Volume Control
- Intercom/Announce Call Transfer
- Handset Conferencing (2 Handsets + Outside Call)
- Two-Way Communication between Handsets Anywhere without the Base
- Dual Keypad at Base
- Integrated Answering Device
- DND Feature (Do Not Disturb)
- Remote Message Retrieval
- Personal or Factory Pre-recorded Greeting Message
- And More!

* Caller ID and POP ID features work only if you subscribe to the service provided by your local telephone company. There is usually a fee for this service.

Range may vary depending on environmental and/or topographical conditions.

CHECKING THE PACKAGE CONTENTS

Make sure you have received the following items in the package. If any of these items are missing or damaged, contact your retailer.



- Base unit (1)
- Handset (3)
- AC adapter (3)
- Rechargeable battery pack (3)
- Line adapter (Australia only) (1)
- Linecord (1)
- Beltclip (3)
- Charger (2)
- Wall Mount Adapter (1)

Also included:

- This Owner's Manual
- Other Printed Material

TERMINOLOGY

Throughout this manual, terms such as Standby and Talk Mode are used. Below is the terminology explanation.

Standby Mode - The handset is not in use, is off the cradle, and /flash or  **speaker**, or  has not been pressed. A dial tone is not present.

Talk Mode - The handset is not in the cradle and /flash or  **speaker**, or  has been pressed enabling a dial tone. "Talk" appears on the handset display.

DirectLink - Two way communication between the handsets anywhere without the base.

MOUNTING THE BASE UNIT ON A WALL

You can mount your base directly to the wall. Before doing this, consider the following:

- Avoid electrical cables, pipes, or other items behind the mounting location that could cause a hazard when inserting screws into the wall.
- Mount your phone within distance of a working phone jack.
- Make sure the wall material is capable of supporting the weight of the base and handset.
- Use screws with anchoring devices suitable for the wall material where the base unit will be placed.

1) Insert two mounting screws into the wall (with their appropriate anchoring device), 100mm apart. Allow about 3mm between the wall and screwheads for mounting the phone.

2) Plug the AC adapter into the **DC IN 9V** jack on the telephone and then into a Standard AC wall outlet.

3) Plug the telephone line cord into the **TEL LINE** jack on the telephone and then into the telephone socket on the wall.

4) Raise the antenna to a vertical position.

5) Align the mounting slots on the base with the mounting posts on the wall.

6) Then push in and down until the phone is firmly seated.

This phone also can be mounted on any standard telephone wall plate (for Australia).

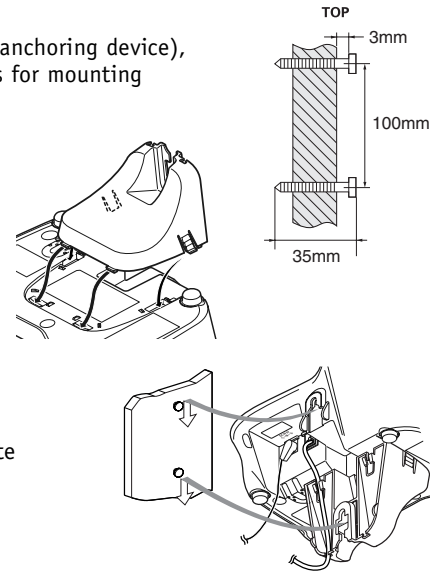

BATTERY MAINTENANCE

Battery use time (per charge)

Fully charged

- Up to 7 hours continuous use
 - Up to 10 days when the handset is in the standby mode (up to 15 hours when in DirectLink mode)
- Recharge your phone on a regular basis by returning the handset to the charger after each phone call.

Low battery alert

When the batteries are very low and need to be charged, the phone is programmed to eliminate functions in order to save power.

The batteries need to be charged when:

- The empty battery icon  appears.
- "Low Battery" appears in the display.

If the phone is in the standby mode, none of keys will operate. If you are on a call, complete your conversation as quickly as possible, and return the handset to the cradle.

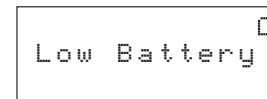

Cleaning the battery charging contacts

To maintain a good charge, it is important to clean the charging contacts on the handset once a month. Use a dry cloth or pencil eraser to clean.

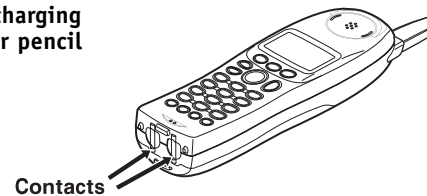

Battery replacement and handling

When the operating time becomes short, even after a battery is recharged, please replace the battery. With normal usage, your battery should last about one year. Please contact your place of purchase or the Uniden Parts Department for a replacement battery.

Caution

- Use only the specified Uniden battery pack (BT-446).
- Do not remove the batteries from the handset to charge them.
- Never throw the battery into a fire, disassemble them, or heat them.
- Do not remove or damage the battery casing.



To avoid the risk of personal injury or property damage from fire or electrical shock, only use the Uniden battery model and Uniden adapter model specifically designated for this product.

INSTALLING THE BELTCLIP

To attach the beltclip

Insert the beltclip into the holes on each side of the handset. Press down until it clicks into place.

To remove the beltclip

Pull either side of the beltclip to release the tabs from the holes.



HEADSET INSTALLATION (OPTIONAL)

The headset is used to make or receive a call. With the headset, you can have the convenience of hands free communication while using your cordless phone.

- 1) Place the headset on your head so the speaker covers your ear. The other end of the headset should rest comfortably against the side of your head above your ear. Do not place the end of the headband against the other ear.
- 2) The microphone arm swings over the top of the headset so you can wear the headset on the left or right ear. Position the flexible arm so the microphone is about 5 cm away from your mouth.
- 3) To use the headset, plug the headset cord into the 2.5mm jack on the side of the handset.

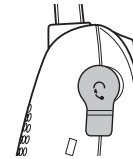

DISPLAY AND ICONS

Example of the standby mode display

SUN 12:00A		Day of the week and time / battery icon
Handset #1		Handset ID and Banner
New: 5		Number of new Caller ID calls received / Ringer off icon (when the ringer is Off)

ICON	STATUS	DESCRIPTION
	Standby/ Talk	Battery icons indicate the handset battery status. This icon cycles depending on the battery status (full, medium, low, and empty).
	Standby	Ringer off icon indicates that ringer is turned off.
	Talk	Mute icon appears when you mute the handset.

ICON	STATUS	DESCRIPTION
	Talk	Speaker icon appears when the handset speaker phone is used.
	Talk	Booster icon appears when the Clarity Booster feature is in use.
	Talk	Privacy icon appears when the Privacy Mode is turned on.
	Talk	Recording icon appears while recording a conversation.



During Global Setup and System Reset, make sure your cordless phone is in standby mode (not in use), and all handsets are within range of the main base unit.

ABOUT THE MENU OPTIONS

There are 6 main menu options, (**DirectLink Mode, Room Monitor, Handset Setup, Answ. Setup, Global Setup and System Reset**) and submenu options.

Summary of the Main Menu and Submenu

Two Way Communication between the Handsets Anywhere without the Base (DirectLink)

DirectLink Mode allows a pair of handsets to work without the base unit, for direct handset-to-handset communication. Use them at sporting events or while shopping to stay in contact with family members or friends. You must set the two handsets to DirectLink Mode to utilize this feature.

Room Monitor

This feature allows you to monitor sounds in another room (see page 15 for setup). One handset is placed in the desired room to monitor (acts as remote mic), and the other is placed near listener (remote speaker). This is useful for monitoring child activities.

Handset Setup

The following submenu options must be set separately for each handset.

Submenu name	Description
Ringer Tones (Default is Flicker)	Adjusting the ringer tone (tone your phone makes when ringing) (see page 16).
Distinct. Ring (Default is on)	Set the distinctive ring (see page 16). "Distinctive Ring" allows you to preset memory locations with a designated ring tone. When an incoming call is received and the Caller ID information matches the information in one of the memory locations, the distinctive ring that has been stored for that particular Caller will sound. If you have set multiple memory locations with distinctive rings, switching the setting to "Distinctive Off" will result in no distinctive ringing. All incoming calls will have a normal ring tone. Switching to "Distinctive On" will activate all programmed distinctive ring memory locations.
AutoTalk (Default is on)	Allows you to answer the phone without pressing (talk)/flash or (M) speaker . When the AutoTalk is set to on, simply remove the handset from the cradle and the phone automatically answers the call (see page 16).
Anykey Answer (Default is on)	Allows you to answer the phone without pressing (talk)/flash or (M) speaker . When the Anykey Answer is on, you can answer a call by pressing any number key, (*)/tone/← , or (#)/→ on the handset (see page 17).
Banner (True Banner)	Customize your handset(s) by giving it a banner name. The name will be displayed on the LCD screen during standby mode, Intercom, Transfer, Room Monitor and Copy Phonebook operation. The banner name will be displayed on the receiving handset as well (see page 17).
Key Touch Tone (Default is on)	Allows you to set your phone's key touch-tone to on or off (tone your keypad makes when keys are pressed) (see page 17).

Answering Setup

This main menu option allows you to set up TAD settings from your handset. You can also set these submenu options from the base (see page 45).

Submenu name	Description
Security Code (Default is 80)	Select a two-digit Personal Identification Number (PIN) code. A PIN code is required to play your messages from a remote location, you will need to enter a two-digit PIN code (see page 17).
Ring Time (Default is 9 time)	Allows you to set the number of rings the caller hears before your answering system plays the outgoing message. You can set the ring time to answer after four, six, or nine rings. Setting "TS" (Toll Saver), the answering system picks up after six rings if you have new messages, and after nine rings if there are none (see page 18).
Record Time (Default is 1 minute)	Set the duration for recording the incoming messages. You have three record time options. The options "1 minute" or "4 minutes" set the duration for recording the incoming messages. "Announce only" answers the call with the preset greeting or your personal greeting but prevents the caller from leaving a message (see page 18).
Message Alert (Default is off)	Lets you know when you have a new incoming message by sounding a short alert tone (see page 18).
Call Screen (Default is on)	Allows you to screen an incoming call before answer the call. Set the call-screening feature to on or off (see page 18).

Global Setup

If you change one of the Global settings, you change the setting for all additional handsets. Only one handset can change Global settings at a time.

Submenu name	Description
Day & time	Set the day and time of your display (see page 19).
Name Tag (POP ID) (Default is on)	Display the stored name with the Caller ID telephone number, if the displayed Caller ID telephone number is exactly the same as a number stored in the phone book (see page 19).
Insert 0	Add "0" or "00" to the number, when you receive the Caller ID message (New Zealand only) (see page 19).
Dial Mode (Australia only) (Default is tone)	Set the dial mode to tone or pulse (see page 20). Most phone systems use tone dialing, which send DTMF tone through phone line. The default is tone dialing. Depends on your dialing system, set the dial mode.
Copy Phonebook	Allow you to transfer the phonebook data stored in one handset to another handset (see page 20).

System Reset

System Reset is used to clear the handset's ID from the main base unit, or the base ID from the handset.

Submenu name	Description
Deregister HS	Clear the handset ID from the base. Use this option, for example, when you change the digital security code (see page 21).
Replacing Base	Clear the base ID. Use this option, for example, if you wish to deregister the base to use the handset with another base of the WDECT2315 and WDECT2355 series (see page 21).



To back to the previous screen, press **menu** / **del**.

SETTING UP THE MENU

Entering the Menu

- 1) Press the **menu** / **del** key in standby mode.
- 2) Use **Δ/vol/▲** or **Δ/vol/▼** to move the pointer to a desired main menu (**DirectLink Mode**, **Room Monitor**, **Handset Setup**, **Answ. Setup**, **Global Setup**, and **System Reset**).
- 3) Press **select** / **☐** to select the desired main menu.
- 4) Use **Δ/vol/▲** or **Δ/vol/▼** to select a desired submenu, and then press **select** / **☐** to enter.

```
▶ DirectLink Mode
Room Monitor
Handset Setup
```

In the submenu, use **Δ/vol/▲** or **Δ/vol/▼** to select an item. Press **select** / **☐** to confirm your selection. For detailed instructions, see the following sections for the desired submenu.

- 5) To exit the menu, press **end** or place the handset to the cradle.

DirectLink Mode

Entering the Two Way Communication between the Handsets Anywhere without the Base

- 1) Enter the DirectLink Mode menu (see "Entering the Menu" on page 14). To enter DirectLink mode press **[SELECT]** appears.
- 2) Press **select** / **☐** to enter the DirectLink mode. You will hear a confirmation tone, and **DirectLink Mode Complete** appears.

```
To enter
DirectLink mode
press [SELECT]
```

To adjust ringer volume, press **Δ/vol/▲** or **Δ/vol/▼** to select one of three ringer volume (off, low, or high).

- 3) To return back to the normal mode, exit the DirectLink mode. To exit the DirectLink mode, press **menu** / **del**, and then **select** / **☐**, or return the handset to the cradle. **DirectLink Mode Cancel** appears.

Room Monitor Using Room Monitor

- 1) Enter the Room Monitor menu (see "Entering the Menu" on page 14).
To Room Monitor appears.
- 2) Select the handset you want to monitor by using Δ /**vol**/ Δ or Δ /**vol**/ ∇ .
- 3) Press **select**/ \boxtimes .
RoomMonitor appears, and you hear sounds in the room where the handset is installed.
- 4) To finish the Room Monitor, press **end** or return the handset to the cradle.

```
To Room Monitor
▶ Handset #2
Base
```

```
RoomMonitor ◀
↔ Handset #2
```



This is an example, if you have handset #1 and #2.

Handset Setup

Selecting a Ringer Tone

- 1) Enter the Handset Setup menu, and then the Ringer Tones submenu (see "Entering the Menu" on page 14).

```
Ringer Tones
▶Flicker
Clatter
```

There are 10 ringer tones or 10 polyphonic tones to choose from.

- Ringers [Flicker, Clatter, Soft Alert, Wake Up, Light Bug, Beep Boop, Tone Board, Chip Chop, Party Clap, Reminder]
- Polyphonic tones [Beethoven's Symphony #9 (Beethoven9), For Elise (Elise), We Wish You A Merry Christmas (Merry-Xmas), Home Sweet Home (Hm Swt Hm), Lorri Song #6 (Lorri Song), When the Irish Eyes Are Smiling (Irish Eyes), Aura Lee, Let Me Call You Sweet Heart (Sweetheart), Waltzing Matilda (W Matilda), Old MacDonald (Old MacDld)]

- 2) Press Δ /**vol**/ Δ or Δ /**vol**/ ∇ to move the pointer. You will hear the ringer or polyphonic tone as you scroll through the options.
- 3) Press select / envelope . You will hear a confirmation tone.

Distinctive Ringer Setup

- 1) Enter the Handset Setup menu, and then the Distinct. Ring submenu (see "Entering the Menu" on page 14).
- 2) Press Δ /**vol**/ Δ or Δ /**vol**/ ∇ to select On or Off.
- 3) Press select / envelope . You will hear a confirmation tone.

```
Distinctive Ring
▶On
Off
```

Setting the AutoTalk

- 1) Enter the Handset Setup menu, and then the Auto Talk submenu (see "Entering the Menu" on page 14).
- 2) Press Δ /**vol**/ Δ or Δ /**vol**/ ∇ to select On or Off.
- 3) Press select / envelope . You will hear a confirmation tone.

```
Auto Talk
On
▶Off
```

Setting the Anykey Answer

- 1) Enter the Handset Setup menu, and then the Anykey Answer submenu (see "Entering the Menu" on page 14).
- 2) Press Δ /**vol**/ Δ or Δ /**vol**/ ∇ to select On or Off.
- 3) Press $\text{\textcircled{select}}$ / $\text{\textcircled{m}}$. You will hear a confirmation tone.

```
Anykey Answer
On
▶ Off
```

Setting the True Banner

- 1) Enter the Handset Setup menu, and then the Banner submenu (see "Entering the Menu" on page 14).
- 2) Use the number keypad (**0-9**), $\text{\textcircled{X}}$ /**tone**/ \leftarrow , $\text{\textcircled{\#}}$ / \rightarrow , or $\text{\textcircled{menu}}$ /**del** to enter or edit the name.
- 3) Press $\text{\textcircled{select}}$ / $\text{\textcircled{m}}$. You will hear a confirmation tone.

```
Banner
#-----#1
```

Setting the Key Touch Tone

- 1) Enter the Handset Setup menu, and then the Key Touch Tone submenu (see "Entering the Menu" on page 14).
- 2) Press Δ /**vol**/ Δ or Δ /**vol**/ ∇ to select On or Off.
- 3) Press $\text{\textcircled{select}}$ / $\text{\textcircled{m}}$. You will hear a confirmation tone.

```
Key Touch Tone
▶ On
Off
```

Answering System Setup

Setting a PIN Code

- 1) Enter the Answ. Setup menu, and then the Security Code submenu (see "Entering the Menu" on page 14).
- 2) Enter a two-digit PIN code (00-99) using the number keypad (**0-9**).
- 3) Press $\text{\textcircled{select}}$ / $\text{\textcircled{m}}$. You will hear a confirmation tone.

```
Security Code
80
```



For Answering Setup menu, you can also set them from the base (see page 45).

Setting the Ring Time

- 1) Enter the Answ. Setup menu, and then the Ring Time submenu (see "Entering the Menu" on page 14).
- 2) Press Δ /**vol**/ Δ or Δ /**vol**/ ∇ to select a Ring Time (Toll Saver, 4 Times, 6 Times, or 9 Times).
- 3) Press \langle select \rangle / \boxtimes . You will hear a confirmation tone.

```

Ring Time
▶ Toll Saver
  4 Times
    
```

Setting the Record Time

- 1) Enter the Answ. Setup menu, and then the Record Time submenu (see "Entering the Menu" on page 14).
- 2) Press Δ /**vol**/ Δ or Δ /**vol**/ ∇ to select Record Time (1 Minute, 4 Minutes, or Announce Only).
- 3) Press \langle select \rangle / \boxtimes . You will hear a confirmation tone.

```

Record Time
▶ 1 Minute
  4 Minutes
    
```

Setting the Message Alert On or Off

- 1) Enter the Answ. Setup menu, and then the Message Alert submenu (see "Entering the Menu" on page 14).
- 2) Press Δ /**vol**/ Δ or Δ /**vol**/ ∇ to select on or off.
- 3) Press \langle select \rangle / \boxtimes . You will hear a confirmation tone.

```

Message Alert
  On
▶ Off
    
```

Setting the Call Screen

- 1) Enter the Answ. Setup menu, and then the Call Screen submenu (see "Entering the Menu" on page 14).
- 2) Press Δ /**vol**/ Δ or Δ /**vol**/ ∇ to select on or off.
- 3) Press \langle select \rangle / \boxtimes . You will hear a confirmation tone.

```

Call Screen
▶ On
  Off
    
```

Global Setup

Setting Name Tag (POP ID)

- 1) Enter the Global Setup menu, and then the Name Tag submenu (see "Entering the Menu" on page 14).
- 2) Press Δ /**vol**/ Δ or Δ /**vol**/ ∇ to change the selection, On or Off.
- 3) Press **select**/ \boxtimes . You will hear a confirmation tone.

Setting Insert Zero (New Zealand only)

- 1) Enter the Global Setup menu, and then the Insert 0 submenu (see "Entering the Menu" on page 14).
- 2) Press Δ /**vol**/ Δ or Δ /**vol**/ ∇ to change the selection, On or Off.
- 3) Press **select**/ \boxtimes . You will hear a confirmation tone.

Setting Day and Time

- 1) Enter the Global Setup menu, and then the Day & Time submenu (see "Entering the Menu" on page 14).
- 2) Press Δ /**vol**/ Δ or Δ /**vol**/ ∇ to select the day of the week, and then press **select**/ \boxtimes .
- 3) Press Δ /**vol**/ Δ or Δ /**vol**/ ∇ to set hour and then press **select**/ \boxtimes .
- 4) Press Δ /**vol**/ Δ or Δ /**vol**/ ∇ to set minute and then press **select**/ \boxtimes .
- 5) Press Δ /**vol**/ Δ or Δ /**vol**/ ∇ to choose AM or PM, and then press **select**/ \boxtimes . You will hear a confirmation tone.

```
Day & Time
SUN 12:00 AM
[←/↑/↓/→/SELECT]
```



- When a Global setting is changed from one handset, this affects all registered handsets.

- For setting the Day and Time, the idle time-out is extended to 2 minutes.



- If you receive a call or set up the Global Setup menu, the transfer will be canceled.
- If an error occurs, the phonebook locations transferred before the error were stored in the receiving handset. `Unavailable` appears on the display.
- When the memory of the receiving handset is full, `Not enough memory in Receiving Handset` appears. You cannot transfer the phonebook location.

Setting the Dial Mode (Australia only)

- 1) Enter the Global Setup menu, and then the Dial Mode submenu (see "Entering the Menu" on page 14).
- 2) Press `▲/vol/▲` or `▲/vol/▼` to change the select, `Tone` or `Pulse` (the initial setting is `Tone`).
- 3) Press `(select)/☑`. You will hear a confirmation tone.

```
Dial Mode
▶Tone
Pulse
```

Copy Phonebook

- 1) Enter the Global Setup menu, and then the Copy Phonebook submenu (see "Entering the Menu" on page 14).
- 2) Press `▲/vol/▲` or `▲/vol/▼` to choose `One Memory` or `All Memory`, and then press `(select)/☑`.
If you choose `All Memory`, go to step 4.
- 3) Press `▲/vol/▲` or `▲/vol/▼`, or the number keypad (**2-9** and **0**) to select the phonebook location you want to export, and then press `(select)/☑`.
- 4) Press `▲/vol/▲` or `▲/vol/▼` to select the handset to which you want transfer the phonebook locations, and then press `(select)/☑`.

```
Copy Phonebook
▶One Memory
All Memory :xxx
```

If you choose `All Memory` in the step 2, `Are you sure?` appears.
Press `▲/vol/▲` or `▲/vol/▼` to select `Yes`, and then press `(select)/☑`.

The phonebook locations will be transferred to the handset. On the receiving handset, `Receiving` and the handset name appear. When the transfer complete, `Done!` appears on the handset.

System Reset

De-register the Handset

- 1) Enter the System Reset menu, and then the Deregister HS submenu (see "Entering the Menu" on page 14).
- 2) Press Δ /**vol**/ \wedge or Δ /**vol**/ \vee to select the handset ID to be de-registered from the list, and then press $\text{\textcircled{select}}$ / $\text{\textcircled{envelope}}$. Deregister HS? appears.
- 3) Press Δ /**vol**/ \wedge or Δ /**vol**/ \vee to select Yes.
- 4) Press $\text{\textcircled{select}}$ / $\text{\textcircled{envelope}}$. You will hear a confirmation tone. When de-registration is complete, Deregistration Complete appears.
- 5) After de-registering the handset, move to "Replacing the Base Setting" below.

```
Which Handset?
▶ Handset #1
  Handset #2
```

```
Deregister HS?
  Yes
▶ No
```

Replacing the Base Setting

- 1) Enter the System Reset menu, and then the Replacing Base submenu (see "Entering the Menu" on page 14). Replace base? appears.
- 2) Press Δ /**vol**/ \wedge or Δ /**vol**/ \vee to select Yes.
- 3) Press $\text{\textcircled{select}}$ / $\text{\textcircled{envelope}}$. You will hear a confirmation tone. The base information will be deleted. When replacing the base is complete, Place handset on main base to register appears, register the handset to the new base (see page 57).

```
Replace base?
  Yes
▶ No
```



NOTE
Make sure to perform the Replacing Base after de-register the handset.



NOTE

- To set Autotalk, see page 16 or to set Anykey Answer see page 17.
- The handset microphone is located at the bottom of the handset (see "Controls and Functions" on page 1). Position yourself as near to the handset as possible and speak clearly.
- If the line is in use by another handset(s), **Line In Use** appears in the display of all registered handset's display, that are not in use.
- The base microphone is located under the base (see "Controls and Functions" on page 1). Position yourself as near to the base as possible.

MAKING AND RECEIVING CALLS

This handset has a built-in speakerphone that allows you to have a hands-free conversation. This feature allows you to communicate easily while performing other tasks, such as cooking. **🔊** appears during hands-free conversations.

You can easily switch a call from normal conversation to hands-free conversation. To switch a call, press **🔊 speaker** during the call.

	From the Handset		From the Base
	Normal conversation	Hands-free conversation	
To answer a call	Handset On the Cradle Pick up the handset (AutoTalk) or pick up the handset and press (talk)/flash . Handset Off the Cradle Press any number key, (X)/tone/← , or (#)/→ (Any Key Answer), or press (talk)/flash .	Handset Off the Cradle Press 🔊 speaker .	Press 🔊 .
To make a call	Handset Off the Cradle 1) Press (talk)/flash . 2) Listen for the dial tone. 3) Dial the number. OR Dial the number, and then press (talk)/flash .	Handset Off the Cradle 1) Press 🔊 speaker . 2) Listen for the dial tone. 3) Dial the number. OR Dial the number, and then press 🔊 speaker .	1) Press 🔊 . 2) Listen for the dial tone. 3) Dial the number.
To hang up	Press (end) , or return the handset to the cradle (AutoStandby).		Press 🔊 .
To enter a pause within the dialing sequence	When you dial the number, press (redial/pause) "P" appears in the display, which represents a pause.		Press 🔊 . When you dial the number press redial/p .

KEYPAD LOCK

The Keypad Lock prevent user from pressing the keypad accidentally. You can still answer calls, and receive page and phonebook locations, and the keypad lock is reactivated after the operation.

To lock the keypad

Press and hold **(X)/tone/←** until you hear a confirmation tone. Keypad Locked appears.

If anykey is pressed when keypad is locked,
To unlock keypad press & hold * key appears.

To unlock the keypad

Press and hold **(X)/tone/←** again. Keypad Unlocked appears.

PLACING A CALL ON HOLD

- 1) During a call, press **(hold)/transfer/int'com** or **hold** on the base. The call will be put on hold.

After 10 seconds of pressing **(hold)/transfer/int'com** or by pressing the **(end)** key, the handset display screen will read, Line On Hold.

- 2) To talk to the caller, press **(talk)/flash** or **(speaker)** on a handset or **(end)** on the base. The phone will return back to the call.

```
Hold, to transfer
▶Handset #2
Handset #3
```

```
SUN 12:00A
Handset #1
Line On Hold
```



NOTE

You can hold a call for 5 minutes, when 5 minutes has passed, the call is disconnected and the phone returns to standby mode.



NOTE

- If the number exceeds 32 digits, only the first 32 digits are retained in redial memory.
- If the redial memory is empty, you will hear a beep.

REDIALING A CALL

The last three phone numbers dialed can be quickly redialed.

Redialing from Standby Mode

- 1) Press **redial/pause** in standby mode.
- 2) Press **redial/pause** again. Each press of **redial/pause** will display one of the last three numbers redialed.
- 3) Press **talk/flash** or **speaker**. The selected number is dialed.
- 4) To hang up, press **end**.

Redialing from Talk Mode

- 1) Press **talk/flash** or **speaker**.
- 2) Press **redial/pause**. The last number dialed will be displayed and redialed. To hang up, press **end**.

Deleting a Redial Record

- 1) Press **redial/pause** in standby mode.
- 2) Press **redial/pause** repeatedly to display the number to be deleted.
- 3) Press **menu/del**.
- 3) Press **up/vol/left** or **up/vol/right** to choose Yes.
- 4) Press **select/envelope**. The redialed number is deleted.

Storing a Redial Record

- 1) Press **redial/pause** in standby mode.
- 2) Press **redial/pause** repeatedly to display the number to be stored.
- 3) Press **select/envelope**. Store/Edit Name appears.
- 4) To complete the setting, follow the steps 3-8 in "Storing Phone Numbers, Names, Distinctive Rings, and Speed dial" on page 30-31.

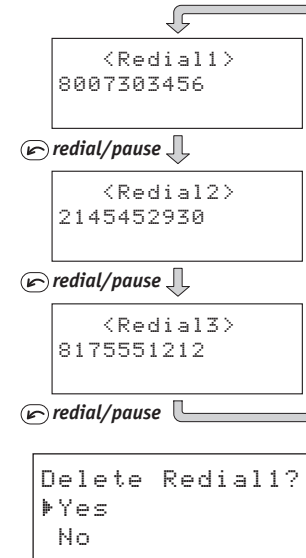

Redialing from the Base

- 1) Press **(Mute)** on the base.
- 2) Press **redial/p** on the base. The last number dialed from the base is redialed.

ADJUSTING THE HANDSET RINGER, EARPIECE AND SPEAKER VOLUME

Handset ringer volume

Press the volume up key or volume down key (labeled as **Δ/vol/▲** or **Δ/vol/▼**) in standby mode to select one of three ringer volume (off, low, or high).

Earpiece and speaker volume

Pressing the volume up key or volume down key (labeled as **Δ/vol/▲** or **Δ/vol/▼** key) during a call will change the earpiece volume of the handset. This setting will remain in effect after the telephone call has ended.

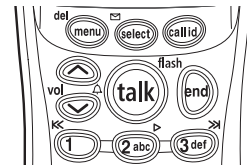

Standby Mode - The handset is not in use and **(talk)/flash** has not been pressed.



When you press volume up key (**Δ/vol/▲**) in the maximum volume level or volume down key (**Δ/vol/▼**) in the lowest volume level, an error tone sounds.

Ringer Mute

You can temporarily mute the incoming ring. When the handset is off the cradle and the phone is ringing, press **(end)**. The incoming ring will return to the previous setting starting with the next incoming call.



- **Standby Mode** - The handset is not in use and **talk/flash** has not been pressed.
- Setting the DND to on while the answering system is off turns the answering system on automatically. The answering system returns to the original setting when you cancel the DND.
- If you press **ans on/off** when the DND and the answering system is on, both of the DND and the answering system will turn off.

DO NOT DISTURB (DND)

DND allows you to mute the ringer of the handset and the base at once. Additionally, if you have more than one handset, ringer for all handsets will be muted. To do this, in the standby mode, press and hold **do not disturb** on the base. You will hear a confirmation tone and the **DND LED** illuminates. To cancel, press **do not disturb** again. You can also mute the ringer tone while the phone is ringing by pressing **do not disturb** on the base.

To mute the ringer tone for each handset or the base temporarily, when the phone is ringing:

- Press **end** on the handset, or
- Press **play/stop** on the base.

The ringer tone will return to the previous setting starting with the next incoming call.

MUTE MICROPHONE

With the handset

You can temporarily turn off the microphone so that the person you are talking with cannot hear you.

- 1) Press **menu/del** during talk mode (while phone is in use).
- 2) Press **▲/vol/▲** or **▲/vol/▼** to move the pointer to **Mute** and then **select/☑**. **Mute On** and **☑** appear in the display. To cancel muting, repeat above step again when **Mute** is set to on, **Mute Off** appears.

With the base

While using the base speakerphone, press **mute/find handset** on the base to turn Off the microphone. Press **mute/find handset** again or press **mute** to cancel muting.

TONE DIALING SWITCH-OVER (AUSTRALIA ONLY)

Some telephone companies use equipment that requires pulse dialing (sometimes referred to as rotary dialing). If you need to enter tone dialing digits, you can switch-over to tone dialing during the call. This feature is useful when you need tone dialing to use automated systems, for example, entering your bank account number after you have called your bank.

Initially make your call with the pulse dialing mode. Once your call connects, press **(X)/tone/←** (or **(X)/tone** on the base). Enter the desired number. These digits will be sent as tone dialing. Once the call ends, the tone mode is canceled and pulse dialing mode resumes.

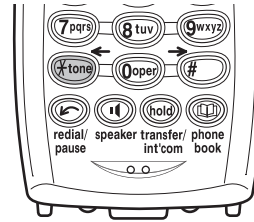

TRAVELING OUT-OF-RANGE

During a call, as you begin to move your handset too far from your base unit, noise may increase. If you pass the range limits of the base unit, you will hear a beep and see *Out of Range* on the display, and then the handset returns to standby mode. You may return to the call if you move your handset within the range limits of the base and press **(talk)/flash** or **(speaker)** within 30 seconds.

CLARITY BOOSTER

If you encounter interference while using your phone, you can manually improve the sound by setting the Clarity Booster to on. **This works only when the phone is in use.**



- The tone feature only applies when the dial mode is set to pulse.
- This special number can be stored in a memory location. This is referred to as Chain Dialing (see page 37)



- Normally, the talk time duration is 7 hours, however, when the Clarity Booster is On, the talk time duration will be up to 5 hours with fully charged batteries.
- Clarity booster automatically turns off after each call.

- 1) Press **[menu]** / **del** during talk time (while phone is in use).
- 2) Press **▲/vol/▲** or **▲/vol/▼** to move the pointer to Clarity Boost, and then **[select]** / **[enter]**. Boost On and B appear in the display. To turn Off the Clarity Booster, repeat above step again when the Clarity Booster is on, Boost Off appears.

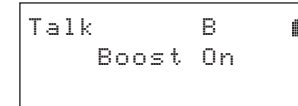

PRIVACY MODE

Privacy Mode allows you privacy, and guarantee of no interruption from other registered handsets. **This works only when the phone is in use.**

- 1) Press **[menu]** / **del** during talk time (while phone is in use).
- 2) Press **▲/vol/▲** or **▲/vol/▼** to move the pointer to Privacy Mode, and then **[select]** / **[enter]**. Privacy Mode On and  appear in the display. To exit the Privacy Mode, repeat above step again when the Privacy Mode is on. Privacy Mode Off appears.

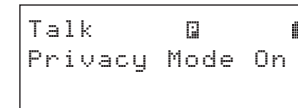

If you have more than one handset, the phone permits 4-way conversations, see "4-way Conferencing" on page 59 for details.

3-WAY CONFERENCING

The phone permits 3-way conversations between the handset, base, and an outside line.

When speaking on the handset

- 1) Press **[mic]** on the base to initiate the 3-way conversation.
- 2) To hang up, press **[mic]** on the base. The handset will still be connected to the call.

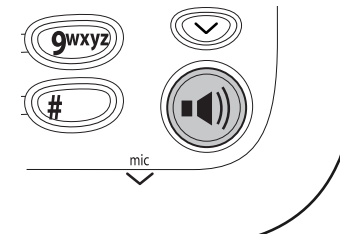

When speaking on the base

- 1) Press **talk/flash** or **speaker** on the handset to initiate the 3-way conversation.
- 2) To hang up, return the handset to the cradle, or press **end** key on the handset. The base will still be connected to the call.

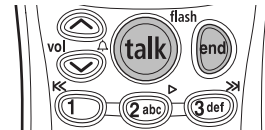

FIND HANDSET

To locate the handset, press **mute/find handset** on the base when the base is in standby mode. All registered handsets beeps for 60 seconds, and Paging appears on the handset display. To cancel paging, press any key on the handset or **mute/find handset** on the base.

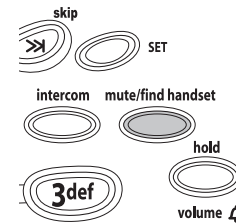

FLASH AND CALL WAITING

If you have Call Waiting service and a call waiting tone sounds while you are on a call, press **talk/flash** (or **flash** on the base) to accept the waiting call. There is a short pause, and then you will hear the new caller. To return to the original caller, press **talk/flash** (or **flash** on the base) again.

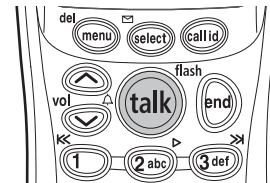

NEW MESSAGE LED

The new message LED on the handset flashes when you have new messages in your answering system. The LED stops flashing when all new messages are played back (see "Using your Answering System" on page 50).



NOTE

- Your phone has 100 memory locations for Caller ID messages or stored Phonebook numbers.
- Selecting a speed dial location where a number is already stored releases the old number's speed dial setting. The new number will be stored in the speed dial location.
- When the memory is full, you will hear a beep and **Memory Full** appears. You cannot store names and numbers.
- The pause key counts as one digit. Pressing **redial/pause** more than once increases the length of the pause between numbers. Each pause represents a 2 second delay.

PHONEBOOK

The Phonebook allows you to dial a number using just a few key presses. Your phone stores names/numbers in the phonebook memory location, and you can search names in alphabetical order. You have a total of 100 locations that can be used for the phonebook (including the speed dials) and Caller ID messages.

STORING PHONE NUMBERS, NAMES, DISTINCTIVE RINGS, AND SPEED DIAL

- 1) When the phone is in standby mode, press **phonebook**.
The handset displays the following items:
(1st line) The number of the phonebook locations used
(2nd line) How to search (press the number keypad, **vol/** or **vol/**)
(3rd line) How to enter the storing operation (press the **select/** key)
- 2) Press **select/**, **Store/Edit Name** appears.
- 3) Enter the name (up to 16 characters) by using the number keypad (see the "Steps for Entering Names and Special Characters" on page 32).
If a name is not required, go to step 4. <No Name> will be used as the name.
- 4) Press **select/** to store the name, **Store/Edit No.** appears.
- 5) Press the number keypad to enter the phone number (up to 20 digits), press **select/** to store the number.

```
Phonebook :100
Search [A-Z/↑/↓]
Store [SELECT]
```

```
Store/Edit Name
Movies
```

```
Store/Edit No.
0295979035#
```

- 6) Distinctive Ring appears. Press Δ /**vol**/ Δ or Δ /**vol**/ ∇ to move the pointer to one of the Distinctive Ring options, and then press select / envelope .

```
Distinctive Ring
▶No Selectn
Flicker
```



If you choose not to store a Distinctive Ring, simply select the "No Selectn" option.

- 7) Speed Dial appears. Press Δ /**vol**/ Δ or Δ /**vol**/ ∇ to move the pointer to select the Speed dial location (10 locations: SPD1-SPD0).

```
Speed Dial
▶No Selectn
SPD1:<Empty>
```



If you choose not to store the name/number as a Speed Dial, simply select the "No Selectn" option.

- 8) Press select / envelope . You will hear a confirmation tone, and Done! appears in the display.

```
Movies
0295979035
#Beethoven9/SPD1
```

STEPS FOR ENTERING NAMES AND SPECIAL CHARACTERS

Refer to the letters on the number keys to select the desired characters. With each press of a number key (**0**-**9**), the displayed character appears in the following order: upper case letters first, lower case letters next and finally the number corresponding to the key.



keys	Number of times key is pressed								
	1	2	3	4	5	6	7	8	9
1	i								
2 abc	A	B	C	a	b	c	2		
3 def	D	E	F	d	e	f	3		
4 ghi	G	H	I	g	h	i	4		
5 jkl	J	K	L	j	k	l	5		
6 mno	M	N	O	m	n	o	6		
7 pqrs	P	Q	R	S	P	q	r	s	7
8 tuv	T	U	V	t	u	v	8		
9 wxyz	W	X	Y	Z	w	x	y	z	9
0 oper	&	<	>	<	>	/	(blank)	-	-
	.	,	:	?	!	@	'	"	*
	#	0							

If you make a mistake while entering a name

Use **X**/*tone*/← or **#**/→ to move the cursor to the incorrect character.
Press **menu** /*del* to erase the wrong character and then enter the correct character.

To delete all characters, press and hold **menu** /*del*.

For example, to enter **Movies**:

- 1) When the phone is in standby mode, press **phonebook**.
- 2) Press **select** / , Store/Edit Name appears.
- 3) Press **6** once, and then press **#**/→ to move the cursor to the right.
- 4) Press **6** six times.
- 5) Press **8** six times.
- 6) Press **4** six times.
- 7) Press **3** five times.
- 8) Press **7** eight times.
- 9) When finished, press **select** / .

To continue to store the telephone number, proceed to step 5 on page 30.



If the next character uses the same number key, you must press **#**/→ to move the cursor over. Otherwise the next time you press the number key, it changes the character that was previously set.

VIEWING THE PHONEBOOK

Your phone stores names/numbers in the phonebook memory locations, and you can search names in alphabetical order. You can view the phonebook even while the phone is in use.

- 1) Press **[PHONEBOOK]** *phonebook*.

If you recall the phonebook during a call, Store [SELECT] will not appear.

```
Phonebook :100
Search [A-Z/↑/↓]
Store [SELECT]
```

- 2) Press **▲/vol/▲**, **▲/vol/▼**, or the number keypad to scroll through the phonebook locations. Phonebook locations appear in alphabetical order (from first to last when you press **▲/vol/▼**, from last to first when you press **▲/vol/▲**).

You can also use letters on the number keys to select the first letter of the desired name. Press a number key (**2-9** and **0**) once for the first letter, press twice for the second letter, and so on. The first location that begins with the letter you entered appears.

For example, to search for "Movies," press **6** once. Press **▲/vol/▲** or **▲/vol/▼**, until the phonebook location is displayed.

- 3) To finish the viewing operation, press **[END]** (or **[PHONEBOOK]** *phonebook* during a call).



NOTE

During a call, don't press **[END]** or the call will be disconnected.

MAKING CALLS USING THE PHONEBOOK

From Standby Mode

- 1) When the phone is in standby mode, view the phonebook location to dial (see "Viewing the Phonebook" on page 34).
- 2) Press **(talk)/flash** or **(speaker)**. The displayed number is dialed.
- 3) To hang up press **(end)**.

```
Movies
0295979035
Beethoven9/SPD1
```

From Talk Mode

- 1) Press **(talk)/flash** or **(speaker)**.
- 2) View the phonebook location to dial (see "Viewing the Phonebook" on page 34).
- 3) Press **(select)/envelope**. The number in the displayed phonebook location is dialed.
- 4) To hang up press **(end)**.

SPEED DIALING

If you store a phone number in a speed dial memory location (10 locations:SPD1 - SPD0), you can use the speed dialing feature. When the phone is in standby mode, press and hold a number key (**(0)-(9)**) associated with the speed dial until the phone number appears, then press **(talk)/flash** or **(speaker)**. The number stored in speed dial (SPD1 - SPD0) is dialed.

EDITING OR ERASING A STORED NAME, PHONE NUMBER, DISTINCTIVE RING, AND SPEED DIAL

- 1) When the phone is in standby mode, press **[phonebook]** *phonebook*.
- 2) Press **[up]/vol/[left]** or **[up]/vol/[down]**, or the number keypad to view the phonebook locations (see "Viewing the Phonebook" on page 34).

```
Phonebook :100
Search [A-Z/↑/↓]
Store [SELECT]
```

a. Editing the Stored Data

- 1) When the phonebook location to be edited appears, press **[select]/[envelope]**. Store/Edit Name appears.
- 2) Follow the steps 3 to 7 under "Storing Phone Numbers, Names, Distinctive Rings, and Speed Dial" on page 30 to complete the editing operation.
- 3) Press **[select]/[envelope]**. You will hear a confirmation tone.

```
Store/Edit Name
Movies
```

b. Deleting the Stored Data

- 1) When the phonebook location to be deleted appears, press **[menu]/del**. Delete Memory? appears.
- 2) Press **[up]/vol/[left]** or **[up]/vol/[down]** to move the pointer to Yes.
- 3) Press **[select]/[envelope]**. You hear a confirmation tone. Deleted! appears in the display.

```
Delete Memory?
Yes
▶ No
```

CHAIN DIALING

The memory locations in the handset are not limited to phone numbers. You can also store a group of numbers (up to 20 digits), that you need to enter once your call connects. This is referred to as Chain Dialing.

An example of this is a bank account number. Store the account or special number in one of the phonebook locations. (Refer to "Storing Phone Numbers, Names, Distinctive Rings and Speed Dial" on page 30.) When you call your bank and you are prompted to enter the account number, scroll through your phonebook locations until you find your account number, and then press /✉.

MEMORY DIALING (BASE ONLY)

You can store 10 phone numbers in the base, and make calls with memory dialing from the base.

Storing Phone Numbers

- 1) Press **mem** in standby mode.
- 2) Enter the number you wish to store. (The number cannot exceed 20 digits.)
- 3) Press **mem**. Enter the memory location number (**0-9**) on the keypad.
You will hear a confirmation tone.

Making Calls with Memory Dialing

- 1) Press  in standby mode.
- 2) Press **mem**. Enter the memory location number (**0-9**) to dial the number.

Deleting the Stored Data

- 1) Press **mem** in standby mode.
- 2) Press **mem** again.
- 3) Enter the memory location number (**0-9**) you wish to delete.
You will hear a confirmation tone.

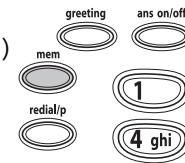

- The 10 memory locations in the base are independent from the handset.
- If you have not pressed any key for 30 seconds, the phone returns to standby mode.



NOTE

- If you answer a call before the Caller ID message is received (for example, before the second ring), the Caller ID message will not appear.
- When the call is received via a telephone company that does not offer Caller ID service, the caller's phone number and name does not appear. (This includes some international calls.)
- When the call is via a private branch exchange (PBX), the caller's phone number and name may not appear.

CALLER ID

You must subscribe to Caller ID services through your local telephone provider to use these features.

When the telephone rings, the Caller ID feature allows you to view the caller's name, and phone number along with the date and time of call. Additionally, you can dial a number stored in the Caller ID list or save data to your Phonebook locations.

Important:

Memory locations for Caller ID messages and Phonebook locations (including Speed Dials) are common, you can store up to 100 in total. A Caller ID message is not stored when you have stored 100 of the phonebook locations. The earliest Caller ID message is overwritten when you have stored 100 of the phonebook locations and Caller ID messages in total.

The date and time received	21/12 11:20AM
Caller's name	Jane Smith
Caller's phone number	0295979035

- 1) When the Caller ID message is received, the display shows the caller's phone number along with the date and time. The incoming call information is stored in the Caller ID record. If the Caller ID service includes the caller's name, the name will appear in the display (up to 15 characters).

You may receive any one of the following messages:

When a private name is received	Private
When a unknown name is received	Unavailable
When a overseas call (0000) is received (New Zealand only)	OVERSEAS CALL
When invalid data is received	Incomplete Data

- 2) When you pick up the phone, the display changes to Talk.
(AutoTalk feature is set to on).



Data errors appear as "■."

VIEWING THE CALLER ID LIST

The Caller ID list stores information for incoming calls - even unanswered calls. You can store 100 of the Caller ID messages and Phonebook locations (including SpeedDials) in total. You can view the Caller ID list during a call or when the phone is in standby mode.

- 1) Press **call id**.

The summary screen appears. The screen shows the number of new messages and total messages.

- 2) To view the Caller ID messages in historical order (from new to old or from old to new), repeatedly press **▲/vol/▼** to scroll through the messages from the latest to the earliest, or **▲/vol/▲** to scroll back through the messages.

To view the Caller ID messages with alphabetical search, press the number key pad (**2-9** and **0**) with the letter associated with the first letter of the desired message.



Once you view the Caller ID list with alphabetical search, you cannot switch back to historical order (from new to old or from old to new) unless you exit and re-enter the operation.

- 3) To finish the viewing operation, press **end** (or **call id** during a call).



- The number of calls from the same Caller ID appears next to the received time. Once you view the new message, the number will be cleared and disappear.

- During a call, don't press end or the call will be disconnected.



- Once the Caller ID data has been deleted, the information cannot be retrieved.

- **Standby Mode** - The handset is not in use and **(talk)/flash** has not been pressed.

- **Talk Mode** - The handset is not in the cradle and **(talk)/flash** or **(speaker)** has been pressed enabling a dial tone. Talk appears on the display.

DELETING A CALLER ID MESSAGE

Deleting Information from the Caller ID List

- 1) When the phone is in standby mode, view the Caller ID information to be deleted (see "Viewing the Caller ID List" on page 39).
- 2) Press **(menu) /del**. Delete Caller ID appears.
- 3) Press **▲/vol/▲** or **▲/vol/▼** to choose Yes.
- 4) Press **(select)/☑**. You will hear a confirmation tone.

```

Delete Caller ID
▶Yes
No
    
```

Deleting all Caller ID names/numbers

- 1) When the phone is in standby mode, press **(call id)**.
- 2) Press **(menu) /del**. Delete All? appears.
- 3) Press **▲/vol/▲** or **▲/vol/▼** to choose Yes.
- 4) Press **(select)/☑**. You will hear a confirmation tone.

```

Caller ID
New : 5
Total: 25
    
```

```

Delete All?
Yes
▶No
    
```

USING THE CALLER ID MESSAGE LIST

Calling a party from the Caller ID list

From Standby mode

- 1) When the phone is in standby mode, view the Caller ID message (see "Viewing the Caller ID List" on page 39).
- 2) Press **(talk)/flash** or **(M) speaker**. The displayed phone number dials automatically.

```
21/12 11:20AM
Jane Smith
0295979035
```

From Talk mode

- 1) Press **(talk)/flash** or **(M) speaker**.
- 2) View the Caller ID message you want to dial (see "Viewing the Caller ID List" on page 39).
- 3) Press **(select)/envelope**. The displayed phone number will be dialed.

Adding Zero to Caller ID message (New Zealand only)

While you review Caller ID information while the Insert Zero option is set to On, "0" is inserted. Refer to page 19 "Insert Zero (New Zealand only)" to set the Insert Zero option to On or Off. New Zealand Telecom customers should leave Insert Zero to On. Other New Zealand companies may require Insert Zero set to Off.

Storing Caller ID messages in the Phonebook

Messages shown in the Caller ID list can be stored in the phonebook. The phone number and name of the party on the Caller ID list can be stored in memory.

- 1) When the phone is in standby mode, view the Caller ID message to be stored.
Then press **(select)/envelope**. **Store/Edit Name** appears.
- 2) To complete the setting, follow the steps 3-8 in "Storing Phone Numbers, Names, Distinctive Rings, and Speed dial" on page 30.



- You cannot make a call from the Caller ID list if your phone is connected to a private branch exchange (PBX).
- If a call comes in via a telephone system that does not offer Caller ID service, no information is stored.
- If the Caller ID message was received as a private/unknown number, or the message does not have the number, you cannot store the message in the Phonebook. If it was received as private/unknown name, the message will be stored as <No Name>.
- Even if the 100 memory locations are full, the message will be stored in the Phonebook. However, the message will be erased from the Caller ID list.

THE INTEGRATED ANSWERING DEVICE

THE INTEGRATED ANSWERING DEVICE

The phone has a built-in answering system that answers and records incoming calls. You can also use your answering system to record a conversation, leave a voice memo message or to announce a special outgoing message to callers when you're away from your phone.

Features

- Digital Tapeless Recording
- Up to 14 Minutes of Recording Time
- Call Screening On/Off
- Personal or Pre-recorded Outgoing Messages
- Time and Day Announcement
- Remote Message Retrieval
- Toll Saver
- Conversation Recording
- Voice Memo
- Message Alert
- Hands Free Speaker Phone at Base

Digital Tapeless Recording allows you to quickly review, save, or delete the messages you choose. You will never have to worry about a tape wearing out, jamming, or resetting improperly.

The Integrated Answering System is easy and convenient to use, but please read through all of the instructions carefully.

Answering System Default Settings

Some answering system functions can be set through the base or handset. Default settings for each function are as follows:

Functions	Default Setting	Reference Page		
		Base	Handset	
Answer On/Off	On	P. 43	-	*To activate the clock and time stamp, you must setup the Time function.
Time	SUN 12:00 AM*	P. 46	P. 19	
Security Code	80	P. 46	P. 17	
Ring Time	9 times	P. 47	P. 18	
Record Time	1 minute	P. 47	P. 18	
Message Alert	Off	P. 48	P. 18	
Call Screen	On	P. 49	P. 18	

TURNING THE ANSWERING SYSTEM ON/OFF

- 1) To turn the answering system on, press **ans on/off** when the phone is in standby mode. After the announcement "Answering System is on," the current greeting message will be played and you will hear a confirmation tone. The message counter displays the number of messages stored in memory. If the display flashes, then there are new messages waiting for you.

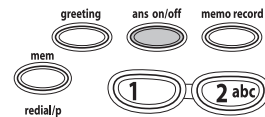

- 2) To turn the answering system off, press **ans on/off**. After the announcement "Answering System is off," the message counter display will no longer be illuminated.



- When the answering system is full, FL appears on the base. You should delete some messages so that the system can record new messages.
- Position yourself as near to the base as possible and speak clearly when recording your outgoing message.
- If you make an outside call, or a call is received on the base during the operation, the operation is canceled.

SETTING UP YOUR ANSWERING SYSTEM

Setting your outgoing message (Greeting)

When you receive a call, the answering system automatically plays either the pre-recorded message or your own personal message (greeting).

Pre-recorded message

The following message is pre-recorded:

"Hello, no one is available to take your call. Please leave a message after the tone."

Recording a personal outgoing message (Greeting)

You can record a greeting up to 30 seconds long (must be more than 2 seconds long).

- 1) When the phone is in standby mode, press and hold **greeting**.
- 2) Start your recording after the announcement "Record greeting."
The message counter displays "- -", then begins to count down.
- 3) When you have finished recording your greeting, press **greeting**, **SET**, or  **play/stop**.

You will hear a confirmation tone and your recorded greeting plays back for you.

Choosing between the two outgoing messages

When the phone is in standby mode, press **greeting**. Press **greeting** again when the outgoing message is played. Each time **greeting** is pressed, the outgoing message is switched between the pre-recorded and the personal outgoing message.

Deleting an outgoing message

To delete the personal outgoing message, press  **delete** while the message is playing. The system announces "Greeting has been deleted."

Setting the base ringer volume

Your base unit has four ringer options, 3 will display for high, 2 for medium, 1 for low and 0 for off.

- 1) When the phone is in standby mode, press Δ /*vol*/ \wedge or Δ /*vol*/ \vee repeatedly to scroll through ringer volumes. The ringer level is displayed, and you will hear each volume level. The last ringer heard will be the volume setting, then the phone returns to standby mode.
- 2) You can also set the base ringer volume while the phone is ringing by pressing the Δ /*vol*/ \wedge or Δ /*vol*/ \vee .

Adjusting the speaker volume level

When the base speaker is in use, press Δ /*vol*/ \wedge or Δ /*vol*/ \vee on the base to adjust the volume. Press Δ /*vol*/ \wedge for louder or Δ /*vol*/ \vee for softer. The number 1-10 appears on the base indicating the volume levels. 1 being the softest and 10 being the loudest.

Answering System Settings

To set the following six functions you must enter the menu mode.

- To scroll through the menu options, repeatedly press **clock/MENU** on the base in standby mode.



The system returns to standby after the last menu option. A confirmation tone sounds to indicate standby mode.

- When you have completed the setting, press \triangleright/\square **play/stop** to exit the menu mode, or **clock/MENU** to move to the next menu option.
- You can also set these menus from the handset. See "Answering System Setup" on page 17 for instructions.

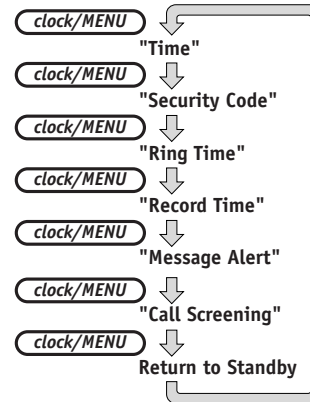

For your convenience, voice prompts will guide you through the menu setup mode.



Time stamp will not be heard until you have set the time.

Setting the Time

Follow these steps to set the clock on the answering system to the correct time.

- 1) Press **clock/MENU**.
- 2) Press **⏪ skip/SELECT** or **⏩ repeat/SELECT** until the correct day is announced and the corresponding number (from 1 Sunday to 7 Saturday) appears.
- 3) Press **SET** to select the day.
- 4) Press **⏪ skip/SELECT** or **⏩ repeat/SELECT** until you hear the correct hour setting. The numbers 1 through 12 appear on the base as each hour is announced.
- 5) Press **SET** to select the hour.
- 6) Press **⏪ skip/SELECT** or **⏩ repeat/SELECT** until you hear the correct minute setting. The numbers 00 through 59 appears on the base as each minute is announced.
- 7) Press **SET** to select the minute.
- 8) Press **⏪ skip/SELECT** or **⏩ repeat/SELECT** until you hear the correct AM or PM setting. The message counter displays **A** or **P**.
- 9) Press **SET** to select the AM/PM setting.
A confirmation tone sounds, and the day and time you set are announced for your review.

Setting a PIN code

To play your messages from a remote location, you will need to enter a two-digit Personal Identification Number (PIN) code. To select a PIN code, perform the following steps:

- 1) Press **clock/MENU** twice. The current PIN code appears on the base and it is announced.
- 2) Press **⏪ skip/SELECT** or **⏩ repeat/SELECT** until the desired number appears. Press and hold **⏪ skip/SELECT** or **⏩ repeat/SELECT** to quickly scroll through the numbers on the display.
- 3) Press **SET** to select the PIN code.
A confirmation tone sounds, the system announces the new PIN code.

Setting the ring time

The ring time setting allows you to set the number of rings the caller hears before your answering system plays the outgoing message. You can set the ring time to answer after four, six, nine rings. If you enable the Toll Saver (TS setting), the answering system picks up after six rings if you have new messages, and after nine rings if there are none. This way, if you make a long distance call to check your messages, you can hang up after the sixth ring to avoid billing charges.

- 1) Press **clock/MENU** three times.
The current ring time setting (4, 6, 9, 15 (Toll saver)) appears on the base and it is announced.
- 2) Press **⊗ skip/SELECT** or **Ⓚ repeat/SELECT** until the desired ring time appears.
- 3) Press **SET** to select the new ring time.
A confirmation tone sounds, system announces the new ring time.

Selecting the message record time

You have three record time options. The options "1 minute" or "4 minutes" set the duration for recording the incoming messages. "Announce only" answers the call with the preset greeting or your personal greeting but prevents the caller from leaving a message.

- 1) Press **clock/MENU** four times.
The current recording time (1 minute, 4 minutes, A (Announce only)) appears on the base and it is announced.
- 2) Press **⊗ skip/SELECT** or **Ⓚ repeat/SELECT** until the desired message record time appears.
- 3) Press **SET** to select the new recording time.
A confirmation tone sounds, system announces the new record time.

Announce only feature

The Announce only feature plays a pre-recorded outgoing message or your own personal outgoing message, but it will not allow the caller to leave a message. To set "Announce only", follow the steps on page 47. To choose between the pre-recorded message or your own personal greeting, press ***greeting***, when the outgoing message is played. Press ***greeting*** to select the greeting of your choice.

If you want to use your own greeting, you may want to change your greeting to omit the prompt to leave a message. Refer to "Recording a personal outgoing message (Greeting)" on page 44.

The following message is pre-recorded:

"Hello, no one is available to take your call. Please call again."

Setting the message alert

The Message Alert feature sounds a short alert tone whenever you have a new message. If you set the Message Alert on, and when a new message is received, the alert tone will sound every 15 seconds. Set the Message Alert to on or off by using ***clock/MENU***.

- 1) Press ***clock/MENU*** five times. The current setting (on or off) appears on the base and it is announced.
- 2) Press ***⏪ skip/SELECT*** or ***⏩ repeat/SELECT*** to choose **On** or **Off**.
- 3) Press ***SET***.

A confirmation tone sounds, and the system announces the current setting you have selected. When the first new message is received, the alert tone will begin to sound.

Turning the message alert tone off by pressing any key

To quickly turn Message Alert tone to off, press any key on the base unit and the tone will automatically deactivate.

Turning the message alert tone off when you are away from your phone

When all new messages are played back using the remote playback feature (see page 53) the Message Alert tone will automatically deactivate. The tone will not deactivate until all new messages are played back.

Setting the call screen

You can screen calls when the Call Screen function is set to On.

- 1) Press **clock/MENU** six times.
The current Call Screen setting (On or Off) appears on the base.
- 2) Press **skip/SELECT** or **repeat/SELECT** to choose On or Off.
- 3) Press **SET**. A confirmation tone sounds, and the system announces the new setting.

Screening a call

From the base

To screen an incoming call, do the following steps as follows:

- 1) After the answering system answers, the base speaker will let you hear the calls as the machine records the message. To adjust the volume, press **▲/vol/▲** or **▲/vol/▼**.

To mute the call screen temporarily, press **▶/□ play/stop** when the system is answering.

- 2) To answer the call, press **☎** or pick up the handset from the base (when AutoTalk is set to On). If the handset is away from the base, press **talk/flash**, **speaker** or any number key, ***/tone/←**, or **#/→** (when Any Key Answer is set to On).
The answering system will disconnect automatically.



From the handset

- 1) Press **select/☐** when the system is answering.

To mute the call screen temporarily, press **end** when the system is answering.

- 2) To answer the call, press **talk/flash**, otherwise press **end** to cancel the call screen and the system return to standby mode.



- If you set the call screen to off, you can not screen a call.
- If you press **talk/flash**, call screen will be canceled and the handset is put in talk mode.
- If you press **select/☐** while another handset is screening a call, you will hear a beep and you can not screen a call.



- The time stamp will not be heard until you have set the time.

- When the answering system is full, FL appears on the base. You should delete some messages so that the system can record new messages. (Refer to "Deleting a message" on page 51.)

USING YOUR ANSWERING SYSTEM

The message counter displays the number of messages stored in memory. If the display flashes, then there are new messages waiting for you. The answering system plays your new messages first. After you play all your new messages, you can then play your old messages.







Playing your messages

- 1) When the phone is in standby mode, press **[▶/□] play/stop**.
The system announces the number of new and old messages while the message counter displays only the number of new messages. The time and day that each message was received is announced after the message is played. The message counter will then display the number of current stored messages.
- 2) When all new messages have been played, you hear a confirmation tone and the system announces "End of messages." The system returns to standby. After you have reviewed your new messages, you can play your old messages by pressing **[▶/□] play/stop** again. Once you have listened to a new message, it then becomes an old message. The old messages will be played in the order in which they were received.

Repeating a message





- 1) Press **[▶/□] play/stop** to review your messages. The number of stored messages is announced.
- 2) To repeat the current message, press **[⏮] repeat/SELECT** after a few seconds of beginning the message. To quickly scroll backwards through a message, press and hold **[⏮] repeat/SELECT**.
To repeat the previous message, press **[⏮] repeat/SELECT** within a few seconds (about 4 seconds during remote operation) after a message begins playing. If you have several messages, press **[⏮] repeat/SELECT** repeatedly until you return to the message you want to replay. If the current message is the first new message, the system plays back from the beginning of the current message (it does not go back into the old message group).
- 3) Press **[▶/□] play/stop** at any time to stop reviewing messages and return to standby. The message counter shows the number of messages stored in memory.

Skipping a message

- 1) Press  **play/stop** to review your messages. The number of stored messages is announced.
- 2) Press  **skip/SELECT** at anytime to skip to the next message.
Each time  **skip/SELECT** is pressed, the system scans forward one message. If you have several messages, press  **skip/SELECT** repeatedly to find the message you want to play.
To quickly scroll through a message, press and hold  **skip/SELECT**. The system advances through the playback at double speed.
- 3) Press  **play/stop** at anytime to stop reviewing your messages and return to standby.
The message counter shows the number of messages stored in memory.

Deleting a message

To maintain maximum record time, delete the old messages.

- 1) Press  **play/stop** to review your messages.
- 2) Press  **delete** at anytime during the message to delete the message. You hear a confirmation tone and the message is deleted.
- 3) To delete all messages, press  **delete** in standby mode. Press  **delete** again after the announcement "To delete all messages, press delete again."

When you try to delete all messages without first listening to your new messages, you hear several short beeps followed by an announcement "Please playback all messages." This protects you from accidentally erasing messages you have not yet reviewed.

Important:

When you press  **delete**, you are permanently deleting the message. Once deleted, the message cannot be replayed or retrieved.



- The voice memo messages are recorded as an incoming messages.
- When the answering system is full, FL appears on the display and recording is terminated.
- If an outside call is received during the operation, the operation is canceled.
- Every state has different regulations governing the recording of conversations over the telephone. Make sure to check your local, state and federal laws before using this product to record any telephone conversation in order to determine that your use is in compliance with such laws or guidelines.
- You cannot record 3-way or intercom conversations.
- When the answering system becomes full, FL appears on the display and recording is terminated.

[52]

Voice memo















The voice memo function allows the user to record messages (more than 2 seconds and within 4 minutes).

- 1) Press and hold **memo record**. You hear a beep.
- 2) Start your recording after the announcement "Record Memo Message" and a confirmation tone. The message counter displays "- -".
- 3) When you have finished, press **memo record**, , **play/stop**, or **SET** to stop recording.
The system returns to standby.

Recording a conversation

You can record a conversation from the handset or the base (more than 2 seconds and within 10 minutes).

From the handset

- 1) During a conversation using the handset, press  / **del** on the handset.
- 2) Press  / **vol** /  or  / **vol** /  to select **Call Record**, and then press  / .
- Recording a Call appears on the handset, and "- -" flashes on the base.
A confirmation tone, that can be heard by both parties, sounds during recording.
- 3) To stop recording, press  / **del** and  / **vol** /  or  / **vol** /  to select **Call Record**, and then press  / . You will hear a confirmation tone.

From the base

- 1) During a conversation using the base speaker phone, press and hold **memo record** on the base until you hear a confirmation tone. The unit begins recording and "- -" flashes on the display. A confirmation tone, that can be heard by both parties, sounds during recording.
- 2) To stop recording, press  **play/stop** or **memo record**. You hear a confirmation tone.

REMOTE OPERATION

You can check, play, or delete messages, even record a new greeting message from a remote location (when you are away from home, or from another room using a handset). Additionally, you can turn On or Off your answering system remotely.

Remote access away from home

You can operate your answering system from a remote location using any touch-tone telephone.

- 1) Call your telephone number and wait for the system to answer. If the answering system is off, it will answer after about 15 rings and sounds a series of beeps.
- 2) During the greeting message (or a series of beeps when the answering system is off), press # and enter your PIN code within 2 seconds (see "Setting a PIN Code" on page 17 or 46).
- 3) The answering system announces the current time and the number of messages stored in memory. You hear "To play incoming messages, press pound-two. For help, press pound-zero." You will hear a beep.
- 4) Enter a command within 15 seconds, each command there after must be entered within 2 seconds. You may select a command from the following chart:

Command	Function	Command	Function
# then 1	Repeat a Message*	# then 6	Answering System On
# then 2	Playing incoming Messages	# then 7	Memo Record/Stop**
# then 3	Skipping a Message	# then 8	Greeting Message Record/Stop**
# then 4	Deleting a Message	# then 9	Answer System Off
# then 5	Stop Operation	# then 0	Help Guidance



- The time stamp will not be heard until you have set the time. See "Setting the Time" on page 46.
- The system will only playback messages for four minutes and then it returns to the command waiting mode. To continue playing your messages, press # then 2 again within 15 seconds.
- If you enter an incorrect PIN code three times, you will hear a beep and the system will return to standby.
- During the remote operation, Lr appears on the base.
- If the answering system is recording an incoming message, the recording operation is canceled when you access your answering system remotely.
- For your convenience a remote operation card is provided for you to use while away from home (refer to page 68).



- When you receive a call, the remote operation is canceled.
- When another handset or base make a call, the remote operation is cancelled.
- During the remote operation “—” appears on the base.
- If you have new messages and old messages, only the new messages will be played. After you have reviewed your new messages, you can play your old messages by again pressing 2.

[54]





- * To repeat a message, press # then 1 within about four seconds to repeat the previous message, or press # then 1 after about four seconds to repeat the current message.
 - ** For the Memo Record and Greeting Message Record functions, the first time you enter the corresponding command, it starts the Recording function. If you want to stop the recording, enter the command again.
- 5) After the command has finished, you hear intermittent beeps indicating that the system is in the command waiting mode. You may enter another command at this time from the chart above.
 - 6) When you are finished, hang up to exit the system. The answering system automatically returns to standby.

Remote access with the handset

You can operate your answering system from another room using a handset.

- 1) When the phone is in standby mode, press /☑ on the handset. Remote Answering Machine operation appears on the handset display. The answering system announces the current time and the number of messages stored in the memory. Messages will be played in the order in which they were received. The time and day that each message was received is announced after the message is played.
- 2) You hear “To play incoming messages, press two. For help, press zero.” You will hear a beep.
- 3) Enter a command within 30 seconds. You may select a command from the following chart:

Remote Key Function

 /1	Repeat a Message*	6	Answering System On
 /2	Playing incoming Messages	7	Memo Record/Stop**
 /3	Skipping a Message	8	Greeting Message Record/Stop**
 /4	Deleting a Message	9	Answer System Off
 /5	Stop Operation	0	Help Guidance

* For Repeat a Message function, press **1** within about four seconds to repeat the previous message, or press **1** after about four seconds to repeat the current message.

** For Memo Record and Greeting Message Record function, the first time you enter the corresponding command, it starts the Recording function. If you want to stop the recording, press **7** or **8**.

- 4) After the command has finished, you hear intermittent beeps indicating that the system is waiting for a command. You may enter another command at this time from the chart above.
- 5) When you are finished, hang up or press  to exit the system. The answering system automatically returns to standby.



NOTE

- To use the WDECT2305, register it to the original base.
- Save this manual for detailed operation.
- All of the handsets ring when a call is received.

EXPANDING YOUR PHONE

EXPANDING YOUR PHONE

4 Multi-Handset Expendability

Your phone supports up to 4 handsets (including the handset(s) supplied with your phone). You can now place a fully-featured cordless handset anywhere AC power is available to connect the handset charger.

Up to 2 handsets can be used for outside and/or intercom call.

Effective combination, for example:

- 4-way conferencing (the base, 2 handsets, and one outside line) while on an intercom call using the other 2 handsets.

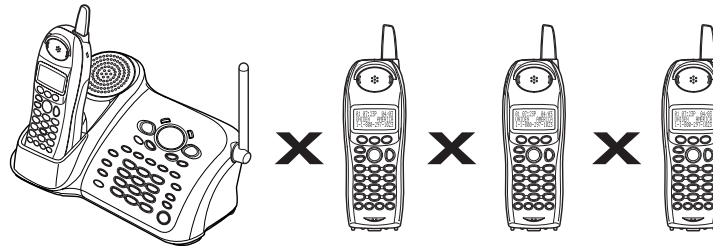

IMPORTANT:

- If you purchase a WDECT2305 extra handset, please register the handset to the WDECT2355 series base before use. The WDECT2305 will not operate until it is registered.
- If you change a setting of the Global Setup menu in one of the handsets, you change settings for all the handsets. For all other features they must be set separately through each handset.

REGISTER THE HANDSET

If you purchase an extra handset, you need to register the handset to the base before use. Only one handset can be registered at a time.

The handset ID for the supplied handset(s) was assigned at the factory, which has #1 or #2 in the display (#2 for models that have two handsets in packaging). When you register additional handset to the base, the handset ID will be assigned.

Place handset
on main base
to register

1) Before registering the extra handset, the battery pack must be charged for 15-20 hours.



2) Place the extra handset in the main base unit to begin registration.



3) While the handset is registering, Handset Registering will appear in the LCD.

When Registration Complete is displayed, the handset has been registered to the base.

If Registration Failed appears, please try these steps again.



- An extra handset can be registered when the main base is in standby mode.
- **Standby Mode** - The handset is not in use and **talk** / **flash** has not been pressed.



Two handsets can be in DirectLink mode while other handsets are in use.

USING TWO WAY COMMUNICATION BETWEEN THE HANDSETS ANYWHERE WITHOUT THE BASE (DIRECTLINK)

To use this feature, you must enter the two handsets into the DirectLink mode first.

To enter the DirectLink mode
 ⇨ See page 14

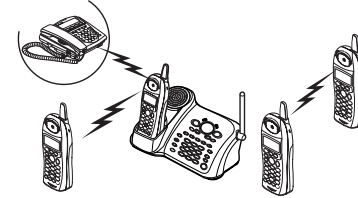

DirectLink Call

- 1) When the phone is in the DirectLink standby mode, press **(talk)/flash** (example of DirectLink from handset #1).
- 2) Select the handset to which you wish to DirectLink with by pressing the number keys **(1-4)**. Your handset will then page the other handset.
- 3) On the receiving handset, press **(talk)/flash**, or if Any Key Answer is on, press any number key, **(X)/tone/←**, or **(#)/→**.
- 4) When you finish your conversation, press **(end)** on either handset. Return the handset to the cradle, or press **(menu)/del**, and then **(select)/☐** to return to normal standby mode (canceling DirectLink mode).

```
SUN 12:00A
Handset #1
DirectLink Mode
```

```
To DirectLink
a handset
press [1-4]
```

```
DirectLink
← Handset #1
```

ROOM MONITOR

This feature allows you to monitor sounds in another room. To use this feature, place the handset in the desired room to monitor (act an remote mic), and place the other near listener (remote speaker). For instruction, see "Using the Room Monitor" on page 15.

4-WAY CONFERENCING

Fourth person, at either the handset or the base, may be added to the conference call. For example, to add a fourth party to an ongoing conference call at the base or another handset, press **(talk)/flash** on the fourth party's handset (or **(M)** on the base). To remove either caller from your conversation, press **(end)** on the party's handset (or **(M)** on the base). The other parties will still be connected to the call.

INTERCOM/CALL TRANSFER FEATURE

Intercom and Call Transfer features are available for your phone.

Intercom

From handset to handset or to the base

- 1) Press **(hold)/transfer/int'com** in standby mode.
- 2) Select the base or the handset you want to talk with from the selection list within 30 seconds. To select the handset (or the base), press **▲/vol/▲** or **▲/vol/▼**, and then press **(select)/☑**. If you select **F11**, all handsets and the base will be paged. An intercom tone sounds.
- 3) On the receiving handset (or the base), to answer the call, press **(talk)/flash** or **(hold)/transfer/int'com** (or **intercom** or **(M)** on the base). Or press any number key, **(X)/tone/←**, or **(#)/→** (when Any Key Answer is on), or pick up the handset from the cradle (when AutoTalk is on).
- 4) To hang up the intercom call, press **(end)** on either handset (or **intercom** on the base).

To intercom	
▶Handset	#2
Handset	#3

From the base to a handset

- 1) Press **intercom** on the base in standby mode.
- 2) Select the handset you want to talk with by pressing number key **(1-4)**. To page all the handsets press **(X)/tone**.
- 3) Follow the steps 3-4 under "From handset to handset or to the base."



NOTE

- If the party is busy or out of range, the handset returns to standby mode.
- If any of the following occurs while selecting the other handset (or the base), the operation will be canceled.
 - Press **(talk)/flash** or **(M)**.
 - Receive an outside/intercom call or page.
- When the party does not answer within one minute, the operation is canceled.
- **Standby Mode** - The handset is not in use and **(talk)/flash** has not been pressed.

Call Transfer Feature

From handset to handset or to the base

- 1) During a call, press **(hold)/transfer/int'com** on the handset.
- 2) Select a handset or the base to transfer the call within 10 seconds. (Refer to step 2 in the intercom section on page 59).

The call will automatically be placed on hold, and an intercom tone sounds.

```
Hold, to transfer
▶ Handset #2
Base
```

To cancel the transfer, press **(talk)/flash** or **(M)** on the initiating handset.

- 3) On the receiving handset, to answer the page, press **(talk)/flash** or **(hold)/transfer/int'com** (or **(M)** or **intercom** on the base). Or press any number key, **(X)/tone/←**, or **(#)/→** (when Any Key Answer is on), or pick up the handset from the cradle (When Auto Talk is on).
- 4) To speak to the caller, press **(talk)/flash** (or **(M)** on the base) on the receiving handset.

From the base to a handset

- 1) During a call, press **intercom** on the base. The call will automatically be placed on hold.
- 2) Select the handset you want to talk with by pressing the number key **(1-4)**. To page all the handsets press **(X)/tone**. An intercom tone sounds. To cancel the transfer, press **intercom** or **(M)** on the base.
- 3) On the receiving handset, press **(talk)/flash** or **(hold)/transfer/int'com** to answer the page. Or press any number key, **(X)/tone/←**, or **(#)/→** (when Any Key Answer is On), or pick up the handset from the cradle (when AutoTalk is On). The intercom mode is activated, but the caller is still on hold.
- 4) To speak to the caller, press **(talk)/flash** or **(M) speaker** on the receiving handset.



NOTE

For model number verification, visit our website
www.uniden.com.au
 or www.uniden.co.nz

REPLACING THE BASE

If the base unit is replaced with a different base from this same series of cordless models, you must clear the handset(s) and base identification numbers. To do this, select "System Reset" from handsets display menu option list (see page 21 for guidance).

CHANGING THE DIGITAL SECURITY CODE

The digital security code is an identification code used to connect the handset and the base unit. Normally, setting the code is not necessary. In the rare situation that you suspect another cordless telephone is using the same security code, you can change the code.

To change the digital security code:

1. Perform the "System Reset" menu options ("De-register the Handset" and "Replacing the Base Setting") for all the handsets you have (see page 21).

2. To register all the handsets do the following steps:

1) Place a handset, one at a time in the base.

2) Registration starts automatically.

While registering Handset Registering appears in the display.

3) When the registration is complete, Registration Complete appears in the display.

4) Repeat steps 1 - 3 for another handsets.

If the registration fails, Registration Failed appears in the display. Try the steps above again.

ADDITIONAL
INFORMATION

TROUBLESHOOTING

If your phone is not performing to your expectations, please try these simple steps first.

Symptom	Suggestion
The charge LED won't illuminate when the handset is placed in the cradle.	<ul style="list-style-type: none"> • Make sure the AC adapter is plugged into the base and wall outlet. • Make sure the handset is properly seated in the cradle. • Make sure the charging contacts on the handset cradle are clean.
The audio sounds weak and/or scratchy.	<ul style="list-style-type: none"> • Move the handset and/or base to a different location away from metal objects or appliances and try again. • Make sure that you are not too far from the base.
Can't make or receive calls.	<ul style="list-style-type: none"> • Check both ends of the base telephone line cord. • Make sure the AC adapter is plugged into the base and wall outlet. • Disconnect the AC adapter for a few minutes, then reconnect it. • Remove the base ID (see "Replacing the Base Setting" on page 21) and register the handset (see "Register the Handset" on page 57). • Make sure that you are not too far from the base. • If an outside call is already established, you may not be able to make another outside call.
The handset doesn't ring or receive a page.	<ul style="list-style-type: none"> • Charge the batteries in the handset for 15-20 hours by placing the handset on the base or charging cradle. • The handset may be too far away from the base unit. • Place the base unit away from appliances or metal objects. • Remove the base ID (see "Replacing the Base Setting" on page 21) and register the handset (see "Register the Handset" on page 57).
"Unavailable" appears in the display.	<ul style="list-style-type: none"> • Make sure that another handset not too far from the base.

Symptom	Suggestion
Severe noise interference.	<ul style="list-style-type: none"> • Keep the handset away from microwave ovens, computers, remote control toys, wireless microphones, alarm systems, intercoms, room monitors, fluorescent lights, and electrical appliances. • Move to another location or turn off the source of interference.
The Caller ID does not display.	<ul style="list-style-type: none"> • The handset was picked up before the second ring. • The call was placed through a switchboard. • Call your local telephone company to verify your Caller ID service is current.
You cannot register the handset at the base.	<ul style="list-style-type: none"> • Charge the battery pack for 15-20 hours. • Remove the base ID (see "Replacing the Base Setting" on page 21) and register the handset (see "Register the Handset to the Base" on page 57).
The handset doesn't communicate with another handsets.	<ul style="list-style-type: none"> • Remove the base ID (see "Replacing the Base Setting" on page 21) and register the handset (see "Register the Handset to the Base" on page 57). • Make sure that you have registered all handsets.
An extra handset can't join the conversation.	<ul style="list-style-type: none"> • Make sure there are not 2 handsets already using the 3-way conference feature.
The handset or the base can't join the conversation	<ul style="list-style-type: none"> • Make sure that more than 2 handsets are not in use. • When recording a conversation, the 2nd handset (or the base) cannot join the conversation.
The answering system does not work.	<ul style="list-style-type: none"> • Make sure the base unit is plugged in. • Make sure that the answering system is turned on. • Make sure that the message record time is not set to Announce only (see page 47).

Symptom	Suggestion
Messages are incomplete.	<ul style="list-style-type: none">•The incoming messages may be too long. Remind callers to leave a brief message.•The memory may be full. Delete some or all of the saved messages.
No sound on the base unit speaker during call monitoring or message playback.	<ul style="list-style-type: none">•Adjust the speaker volume on the base unit.•Make sure the call screen feature is set to on.
Cannot access remote call-in features from another touch-tone phone.	<ul style="list-style-type: none">•Make sure you are using the correct PIN number.•Make sure that the touch-tone phone you're using can transmit the tone for at least two seconds. If it cannot, you may have to use another phone to access your phone.
Time stamp cannot be heard.	<ul style="list-style-type: none">•Make sure you have set the time (see "Setting Day and Time" on page 19 or "Setting the Time" on page 46).
If you still have a problem.	<ul style="list-style-type: none">•Check our website for the latest information and frequently asked questions. www.uniden.com.au www.uniden.co.nz

INDEX

- 0 - 9**
 3-way conferencing28
 4-way conferencing59
 20 ring options16
- A**
 Announce only feature48
 Answering system
 Deleting a message51
 Playing your messages50
 Recording a conversation52
 Remote access.....53
 Repeating a message50
 Skipping a message51
 Turning On/Off43
 Anykey answer.....17
 AutoTalk16
- B**
 Banner17
 Battery
 Preparing and chargingiii
 Replacement and handling8
 Beltclip8
- C**
 Caller ID
 Caller ID service38
 Calling41
 Deleting40
 Storing.....41
 Using.....41
 Viewing39
- Call transfer feature60
 Call Waiting29
 Chain dialing37
 Clock19
 Copy phonebook20
 Clarity Booster27
- D**
 De-register the handset21
 Digital security code61
 DirectLink.....14
 Distinctive ringer.....16
- E, F, G, H**
 Earpiece volume.....25
 Expanding your phone56
 Global setup13
 Handset setup16
 Hands-free conversation22
 Headset installation9
- I, J, K, L**
 Intercom59
 Key touch tone17
- M, N, O**
 Making a call22
 Mute26
 Outgoing message44
- P, Q**
 Phonebook
 Editing.....36
 Erasing.....36
 Making calls35
- Storing.....30
 Viewing34
 Privacy Mode.....28
- R**
 Receiving a call22
 Redialing a call24
 Register the handset57
 Remote access
 away from home53
 from your handset54
 Replacing the base.....60
 Ringer
 Adjust, base44
 Adjust, handset25
 mute25
 Do not disturb.....26
 Room Monitor10
- S**
 Setting up
 base unitii
 extra handset57
 handset16
 Speed dialing35
 System reset13
- T, U, V, W, X, Y, Z**
 Toll saver47
 Transferring a call60
 Troubleshooting62
 Voice memo52
 Warranty.....66

WARRANTY

One Year Limited Warranty

Important: Evidence of original purchase is required for warranty service.

Warrantor: Uniden Australia Pty Limited A.B.N. 58 001 865 498
Uniden New Zealand Limited

ELEMENT OF WARRANTY: Uniden warrants to the original retail owner for the duration of this warranty, its WDECT2355+2 (herein after referred to as the Product), to be free from defects in materials and craftsmanship with only the limitations or exclusions set out below. Warranty is only valid in the original country of purchase.

WARRANTY DURATION: This warranty to the original retail owner only, shall terminate and be of no further effect 12 months after the date of original retail sale. This warranty will be deemed invalid if the product is;

- (A) Damaged or not maintained as reasonable and necessary,
- (B) Modified, altered or used as part of any conversion kits, subassemblies, or any configurations not sold by Uniden,
- (C) Improperly installed,
- (D) Repaired by someone other than an authorized Uniden Repair Agent for a defect or malfunction covered by this warranty,
- (E) Used in conjunction with any equipment or parts or as part of a system not manufactured by Uniden.

PARTS COVERED: This warranty covers for one (1) year, the base, charger and handsets (3) (WDECT2355+2). All accessories (AC Adapter etc) are covered for 90 days only.

STATEMENT OF REMEDY: In the event that the product does not conform to this warranty at any time while this warranty is in effect, the warrantor at its discretion, will repair the defect or replace the product and return it to you without charge for parts or service. THIS WARRANTY DOES NOT COVER OR PROVIDE FOR THE REIMBURSEMENT OR PAYMENT OF INCIDENTAL OR CONSEQUENTIAL DAMAGES. THIS GUARANTEE IS IN ADDITION TO AND DOES NOT IN ANY WAY AFFECT YOUR RIGHTS UNDER THE CONSUMER GUARANTEE ACT.

PROCEDURE FOR OBTAINING PERFORMANCE OR WARRANTY: In the event that the product does not conform to this warranty, the Product should be shipped or delivered, freight pre-paid, with evidence of original purchase (eg. a copy of the sales docket), to the warrantor at:

UNIDEN AUSTRALIA PTY LIMITED SERVICE DIVISION

345 Princes Highway, Rockdale NSW 2216

Fx (02) 9599 3278

www.uniden.com.au

UNIDEN NEW ZEALAND LIMITED SERVICE DIVISION

150 Harris Road, East Tamaki, Auckland

Fx (09) 274 4253

www.uniden.co.nz

Customers in other States should ship or deliver the Product freight pre-paid to their nearest Uniden Authorized Repair Centre (Contact Uniden for the nearest Warranty Agent to you).

REMOTE OPERATION CARD

CUT

REMOTE OPERATION CARD

Uniden[®]

Remote access away from home

1. Call your phone number from a touch-tone phone.
2. During the outgoing message, press **#** and enter your PIN code. The answering system announces the number of messages stored in memory and the help guidance.
3. To quit, hang up the phone.

Turn on the answering system remotely

1. Call your phone and let it ring 15 times until you hear a beep.
2. Press **#** and then enter your PIN code.
3. Press **#** then 5 to stop the announcement.
4. Press **#** then 6 to turn the answering system on.

CUT

Task	Key
Repeat a Message	# 1
Playing incoming Messages	# 2 abc
Skipping a Message	# 3 def
Deleting a Message	# 4 ghi
Stop Operation	# 5 jkl
Answering System On	# 6 mno
Memo Record/Stop	# 7 pqrs
Greeting Message Record/Stop	# 8 tuv
Answer System Off	# 9 wxyz
Help Guidance	# 0 oper

MEMO

Additional Handset & Charger

Expand Your System!

WDECT2305 HANDSET & CHARGER

Easily expand your cordless phone system by adding the WDECT2305 Handset and Charger*. The WDECT2305 gives you the mobility you need to stay connected with friends and family. Place this handset and charger in any convenient location, no need for an extra phone jack! Another innovation from Uniden, the company that bring outstanding wireless communication products to people's lives throughout the world.

* Operates with Multi Handset Cordless Systems: WDECT2315/ WDECT2355 Series



AVAILABLE AT PARTICIPATING RETAIL STORES

Uniden®

Optional Cordless Handset and Charging Cradle

For use with Multi Handset Cordless Systems: WDECT2315/ WDECT2355 Series

Call Transfer

CallerID

No Phone Jack Needed

© 2004

Uniden Australia Pty Limited

Uniden New Zealand Limited

Printed in China

UPZZ01354BZ